

# Maxi Accu - MA

400 l.

EN



SAFETY INFORMATION  
O&M INFORMATION  
INSTALLATION MANUAL  
TDS - TECHNICAL DATA SHEET



Manufactured by OSO Hotwater AS  
Industriveien 1 - 3300 Hokksund - Norway  
Tel: + 47 32 25 00 00 / Fax: + 47 32 25 00 90  
E-mail: oso@oso.no / www.osohotwater.com

145952-04 - 12-2021

**OSO**  
HOTWATER

# CONTENTS

|   |    |
|---|----|
| <b>1. Safety instructions</b> .....           | 3  |
| 1.1 General information.....                  | 3  |
| 1.2 Safety instructions for users .....       | 4  |
| 1.3 Safety instructions for installers.....   | 4  |
| <b>2. Product description</b> .....           | 5  |
| 2.1. Product identification .....             | 5  |
| 2.2. Intended use.....                        | 5  |
| 2.3 CE marking .....                          | 5  |
| 2.4 Technical data .....                      | 5  |
| 2.5. ErP data (TDS) .....                     | 5  |
| <b>3. Installation instructions</b> .....     | 6  |
| 3.1. Products covered by these instructions   | 6  |
| 3.2. Included in delivery.....                | 6  |
| 3.3. Product dimensions.....                  | 6  |
| 3.4. Requirements for installation location . | 7  |
| 3.5. Pipe installation.....                   | 8  |
| <b>4. Initial commissioning</b> .....         | 10 |
| 4.1. Filling with water.....                  | 10 |
| 4.2. Control points .....                     | 10 |
| 4.4. Emptying of water .....                  | 10 |
| 4.5. Handover to end-user.....                | 10 |
| <b>5. Troubleshooting</b> .....               | 10 |
| 5.1. Faults and fixes.....                    | 10 |
| <b>6. Warranty conditions</b> .....           | 11 |
| 6.1. Warranty and registration .....          | 11 |
| 6.2. Customer service.....                    | 11 |
| <b>7. Removing the product</b> .....          | 11 |
| 7.1. Removal.....                             | 11 |
| 7.2. Returns scheme.....                      | 11 |

# 1. SAFETY INSTRUCTIONS

## 1.1 General information



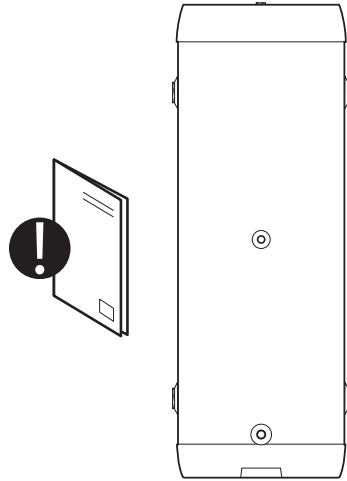

- Read the following safety instructions carefully before installing, maintaining or adjusting the buffer tank.
- Personal injury or material damage may result if the product is not installed or used in the intended manner.
- Keep this manual and other relevant documents where they are accessible for future reference.
- The manufacturer assumes compliance (by the end-user) with the safety, operating and maintenance instructions supplied and (by the installer) with the fitting manual and relevant standards and regulations in effect at the date of installation.





Symbols used in this manual:





|  |         |  |
|--|---------|--|
|  | WARNING | Could cause serious injury or death                        |
|  | CAUTION | Could cause minor or moderate injury or damage to property |
|  | DO NOT  |  |
|  | DO      |  |





## 1.2 Safety instructions for users

|  WARNING |  |
|---|--|
|            | The overflow from the safety valve shall NOT be sealed or plugged.   |
|            | The product shall NOT be modified or changed from its original state.  |
|            | Children shall NOT play with the product or go near it without supervision.                                    |
|            | Maintenance/settings should only be carried out by persons over 18 years of age, with sufficient understanding |

|  CAUTION |  |
|---|--|
|            | The product must not be exposed to frost, over-pressure, over-voltage or chlorine treatment. See warranty provisions.  |
|            | Maintenance/settings shall not be carried out by persons of diminished physical or mental capacity, unless they have been instructed in the correct use by someone responsible for their safety. |

## 1.3 Safety instructions for installers

|  WARNING |  |
|---|--|
|            | The overflow from the safety valve shall NOT be sealed or plugged.   |
|            | Any overflow pipe from the safety valve MUST be $\geq 18$ mm inside, clear, undamaged and frost-free with a fall to the drain. |
|            | The relevant regulations and standards, and this installation manual, must be followed.  |

|  CAUTION |  |
|---|--|
|            | The product shall be placed in a room with a floor drain. The manufacturer assumes no responsibility whatsoever if this provision is not followed.                   |
|            | The product should be properly aligned vertically and horizontally, on a level floor suitable for the total weight of the product when in operation. See type plate. |
|          | The product must have a clearance for servicing of 40 cm in front of front / 10 cm over the highest point.   |

## 2. PRODUCT DESCRIPTION

### 2.1 Product identification

Identification details for your product can be found on the type plate fixed to the product. The type plate contains details of the product in accordance with EN 12897:2016 as well as other useful data.

See Declaration of Conformity at [www.osohotwater.com](http://www.osohotwater.com) for more information.

OSO products are designed and manufactured in accordance with:

- Pressure Equipment Directive PED 2014/68/EU
- Welding standard EN ISO 3834-2

OSO Hotwater AS is certified for

- Quality ISO 9001
- Environment ISO 14001
- Work environment ISO 45001

### 2.2 Intended use

The Maxi is designed for use as a buffer tank for heat pumps/solar collectors, or as a cooler tank in cooling systems etc.

### 2.3 UKCA marking



The UKCA mark shows that the product complies with the relevant Directives. See Declaration of Conformity at [www.osohotwater.com](http://www.osohotwater.com) for more information.

The safety valve(s) used must be CE marked and conform to PED 2014/68/EU.

### 2.4 Technical data

| Product no. | Product code: | Capacity, persons | Weight, kg. | Packaging dimensions LxWxH mm. | Freight vol. m <sup>3</sup> | Heating time, hours $\Delta t$ 65°C | Actual vol. l. |
|-------------|---------------|-------------------|-------------|--------------------------------|-----------------------------|-------------------------------------|----------------|
| 800 1352    | MA 400        | -                 | 77          | 600x600x2245                   | 0.79                        | -                                   | 379            |

### 2.5 ErP data - Technical Data Sheet

| Brand   | Product no. | Model name | ErP profile            | ErP rating | AEC - kWh/a             | Thermostat setting °C | Volume 40°C water | Heat loss W |
|---|-------------|------------|------------------------|------------|-------------------------|-----------------------|-------------------|-------------|
| OSO Hotwater AS                                   | 800 1352    | MA 400     | -                      | C          | -                       | -                     | -                 | 87          |
| Directive: 2010/30/EU Regulation: EU 812/2013     |             |            | Directive: 2009/125/EC |            | Regulation: EU 814/2013 |                       |                   |             |
| Heat loss tested acc. to standard: EN 12897: 2015 |             |            |                        |            |                         |                       |                   |             |

### 3. INSTALLATION INSTRUCTIONS

#### 3.1 Products covered by these instructions

800 1352 MA 400

#### 3.2 Included in delivery

| Ref no. | Number of | Description                         |
|---------|-----------|-------------------------------------|
| 1       | 1         | Buffer tank without electric        |
| 2       | 1         | Installation manual (this document) |
| 3       | 1         | Safety valve 3 bar                  |

#### 3.3 Product dimensions

All dimensions in mm.

| Product. | A    | B    | C   | ∅   |
|----------|------|------|-----|-----|
| MA 400   | 2240 | 1911 | 291 | 595 |

Tolerance +/- 5 mm

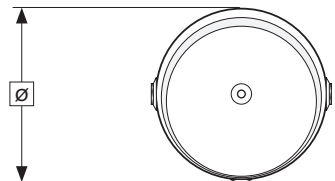
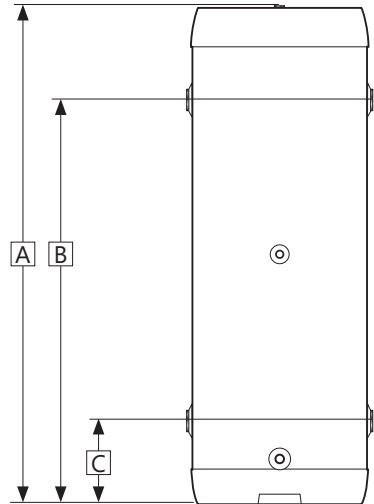
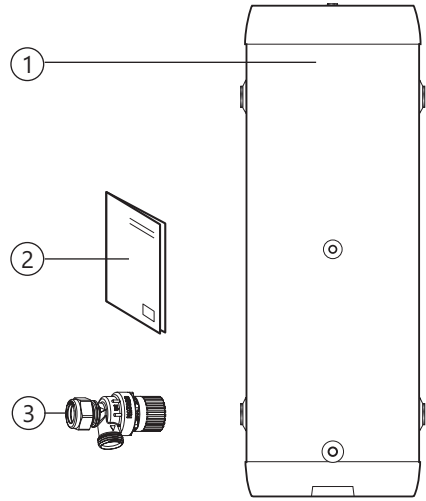

### 3.3.1 Delivery

The product should be transported carefully as shown, with packaging. Use the handles in the box.



|  |
|--|
| <b>⚠ CAUTION</b>   |
| Pipe stubs, valves etc. should not be used to lift the product as this could cause malfunctions. |

### 3.4 Requirements for installation location and positioning

| <b>⚠ CAUTION</b> |   |
|------------------|---|
| <b>❗</b>         | The product shall be placed in a room with a floor drain.<br>The manufacturer assumes no responsibility whatsoever if this provision is not followed. |
| <b>❗</b>         | The product shall be placed in a dry and permanently frost-free position.   |
| <b>❗</b>         | The product shall be placed on a flat surface suitable for the total weight of the product when in operation. See type plate.                         |
| <b>❗</b>         | The product must have a clearance for servicing of 40 cm in front of front / 10 cm over the highest point.  |
| <b>❗</b>         | The product shall be easily accessible for servicing and maintenance.   |

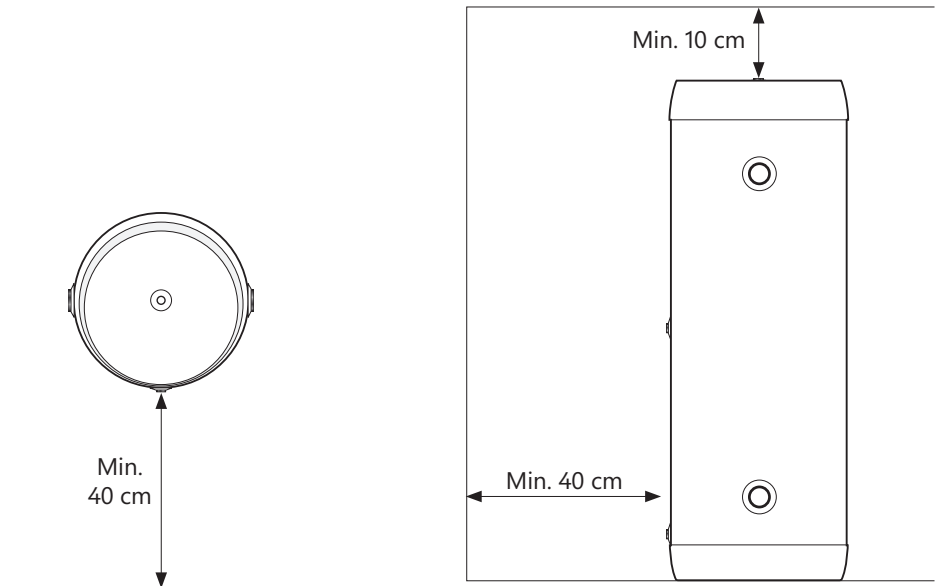

### 3.5 Pipe installation

Approved pipes of the correct size should be used for installation. The relevant standards and regulations must be followed.

| No. | Dimension            | Connection description     |
|-----|----------------------|----------------------------|
| 1   | 3/4" internal thread | Venting                    |
| 2   | 2" int. thread       | Return                     |
| 3   | 1/2" int. thread     | Safety valve / thermometer |
| 4   | 2" int. thread       | Return                     |
| 5   | 3/4" internal thread | Draining / safety valve    |

#### 3.5.1 Incoming water pressure

The product is designed for a max. operating pressure of 10 bar.

#### 3.5.2 Fitting pipes

A) Run a pipe of suitable size to the connections shown, and fix with suitable sealant. Unused connections must be plugged securely.

#### 3.5.3 Safety valve

The supplied SV-381 safety valve is dimensioned for 10kW effect. It shall be fitted in connection (3) by removing the nut and olive (6) from the valve, then inserting the exposed 1/2" thread into connection (3).

If it is desirable to fit a thermometer in connection (3) the safety valve can be fitted to the draining connection (5) by using a 3/4" adapter (not included).

Ensure that your installation has sufficient dimensioning of safety equipment in accordance with PED 2014/68 / EU.

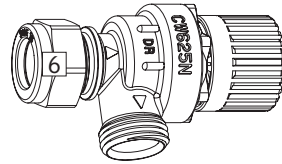
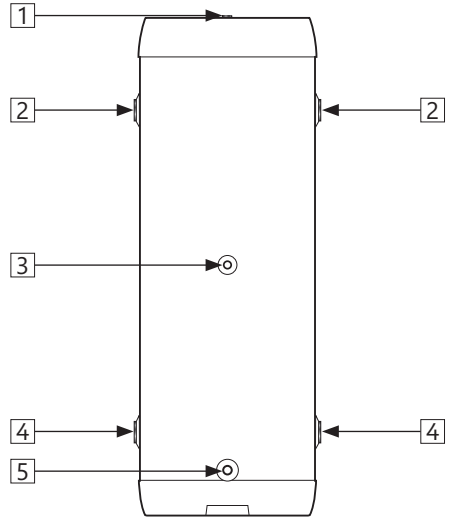



### 3.5.4 Fitting instructions

#### ⚠ CAUTION

|   |   |
|---|---|
| ❗ | The product shall be placed in a room with a floor drain.<br>The manufacturer assumes no responsibility whatsoever if this provision is not followed.         |
| ❗ | The product shall be properly aligned vertically and horizontally, on a floor suitable for the total weight of the product when in operation. See type plate. |
| ❗ | The product must have a clearance for servicing of 40 cm in front of front / 10 cm over the highest point.  |

### 3.5.5 Fitting recommendation

#### RECOMMENDATION

|   |  |
|---|--|
| - | If the maximum water pressure exceeds 6 bar in a 24-hour period, a reduction valve and expansion vessel shall be fitted. |
|---|--|

## 4. INITIAL COMMISSIONING

### 4.1 Filling with water

First check that all pipes are connected correctly. Then proceed as follows:

- Open for venting at a point in the system higher than the top of the tank; use e.g. the 3/4" top connection on the product.
- Open the water supply to the product. When water flows out of the venting point, the tank is full and the vent can be sealed.

### 4.2 Control points

- Check that all pipe connections to/from the product are tight and not leaking.
- Check that the product is standing firmly vertically and horizontally.

### 4.3 Emptying of water



WARNING

The water temperature in the product may exceed 75°C and could cause scalding. Use caution when emptying the product.

- Shut off/disconnect from the heat source.
- Close the incoming water supply.
- Open fully for venting, use venting connection at the top of unit – leave open (prevents vacuum).
- Remove drain plug (2). The product will drain. After emptying close the venting connection and refit the drain plug before the product is refilled with water.

### 4.4 Handover to end-user

#### THE INSTALLER MUST:

- |  |
|--|
| Brief the end-user on safety and maintenance instructions. |
| Brief the end-user on settings and emptying the product.   |
| Hand this installation manual over to the end-user.        |
| Enter contact details on the type plate on the product.    |

## 5. TROUBLESHOOTING

### 5.1 Faults and fixes

If problems arise when the product is in use, check for these possible faults:

- Water leaking from pipe connection. Possible cause: Pipe connection is loose or sealant is insufficient. Possible solution: Tighten pipe connection, replace sealant if necessary.
- Water leaking from the tank, not the pipe connection. Possible cause: Leakage from the steel tank. Possible solution: Check if it is possible to see the leak point. Contact installer.

If you are unsure what is wrong, contact the installer (see product type plate) or OSO Hot-water AS - see section 6.1.

### 5.2 Maintenance

#### MAINTENANCE INSTRUCTIONS

|   |   |
|---|---|
| ❗ | Maintenance should be carried out by persons over 18 years of age, with sufficient understanding.   |
| ❗ | Annual inspection of safety valve:  |
| - | Open valve for 1 min. by turning knob (1) approx. 90 degrees counterclockwise to the open position. |
| - | Visually check that the water is flowing freely to the drain.                                       |
| - | YES = OK. Close the valve by turning knob (1) further counterclockwise.                             |
| - | NO = NOT OK. Disconnect power supply / shut off water supply. Contact installer.                    |

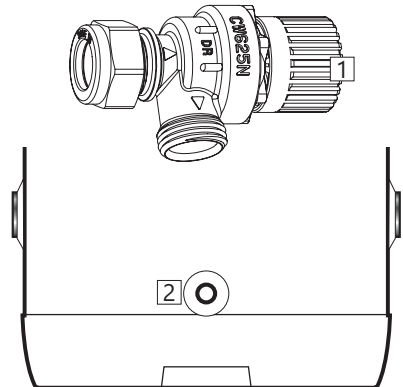

## 6. WARRANTY CONDITIONS - applies to UK only

### 1. Scope

OSO Hotwater AS (hereinafter called OSO) warrants for 2 years from the date of purchase, that the Product will: i) conform to OSO specification, ii) be free from defects in materials and workmanship, subject to conditions below. All components carry a 2-year warranty.

The warranty is voluntarily extended by OSO to 5 years for the stainless steel inner tank. The conditions and limitations set out below shall apply.

### 2. Coverage

If a defect arises and a valid claim is received within the statutory warranty period, at its option and to the extent permitted by law, OSO shall either: i) repair the defect, or; ii) replace the product with a product that is identical or similar in function, or; iii) refund the purchase price.

If a defect arises and a valid claim is received after the statutory warranty period has expired, but within the extended warranty period, OSO will supply a product that is identical or similar in function. OSO will in such cases not cover any other associated costs.

Any exchanged Product or component will become the legal property of OSO. Any valid claim or service does not extend the original warranty. The replacement Product or part does not carry a new warranty.

### 3. Conditions

The Product is manufactured to suit most public water supplies. However, there are certain water chemistries (outlined below) that can have a detrimental effect on the Product and its life expectancy. If there are uncertainties regarding water quality, the local water supply authority can supply the necessary data.

The warranty applies only if the conditions set out below are met in full:

- The Product has been installed by a professional installer, in accordance with the instructions in the installation manual and all relevant Codes of Practice and Regulations in force at the time of installation.
- The Product has not been modified in any way, tampered with or subjected to misuse and no factory fitted parts have been removed for unauthorized repair or replacement.
- The Product has only been connected to a domestic mains water supply in compliance with the European Drinking Water Directive EN 98/83 EC, or latest version. The water should not be aggressive, i.e. the water chemistry shall comply with the following:

|                                    |                 |
|------------------------------------|-----------------|
| - Chloride                         | < 250 mg / L    |
| - Electric Conductivity (EC) @25°C | < 750 uS / cm   |
| - Saturation Index (LSI) @80°C     | > - 1,0 / < 0,8 |
| - pH level                         | > 6,0 / < 9,5   |

- The immersion heater has not been exposed to hardness levels exceeding 5°dH (90 ppm CaCO<sub>3</sub>). A water softener is recommended in such cases.
- Any disinfection has been carried out without affecting the Product in any way whatsoever. The Product shall be isolated from any system chlorination.
- The Product has been in regular use from the date of installation. If the Product is not intended to be used for 60 days or more, it must be drained.
- Service and/or repair shall be done according to the installation manual and all relevant codes of practice. Any replacement parts used shall be original OSO spare parts.
- Any third-party costs associated with any claim has been authorized in advance by OSO in writing.
- The purchase invoice and/or installation invoice, a water sample as well as the defective product is made available to OSO upon request.

Failure to follow these instructions and conditions may result in product failure, and water escaping from the Product.

### 4. Limitations

The warranty does not cover:

- Any fault or costs arising from incorrect installation, incorrect application, lack of regular maintenance in accordance with the installation manual, neglect, accidental or malicious damage, misuse, any alteration, tampering or repair carried out by a non-professional, any fault arising from the tampering with or removal of any factory fitted safety components or measures.
- Any consequential damage or any indirect loss caused by any failure or malfunction of the Product whatsoever.
- Any pipework or any equipment connected to the Product.
- The effects of frost, lightning, voltage variation, lack of water, dry boiling, excess pressure or chlorination procedures.
- The effects of stagnant (de-aerated) water if the Product has been left unused for more than 60 days consecutively.
- Damage caused during transportation. Buyer shall give the carrier notice of such damage.
- Costs arising if the Product is not immediately accessible for servicing.

The warranty is void if the Service Log Book in this manual has not been completed by installer and the service interval record has not been filled in after each service/inspection.

These warranties do not affect the Buyer's statutory rights.

The warranty conditions are not valid outside of the UK.

## 6.1 Customer service

In case of problems that cannot be resolved with the aid of the troubleshooting guide in this installation manual, contact either:

A) The installer who supplied the product.

B) OSO Hotwater (UK) Limited:

Phone: (0191) 482 0800

Fax: (0191) 491 3655

E-mail: [technical.uk@oso-hotwater.co.uk](mailto:technical.uk@oso-hotwater.co.uk)

## 7. REMOVING THE PRODUCT

### 7.1 Removal

- A) Disconnect the power supply.
- B) Shut off incoming cold water supply.
- C) Empty the product of water – see section 4.4.
- D) Disconnect all pipes.
- E) The product can now be removed.

### 7.2 Returns scheme

This product is recyclable and should be taken to the environmental recycling centre. If the product is to be replaced with a new one, the installer can take the old cylinder away for recycling.

# OSO

## HOTWATER

### **OSO Hotwater (UK) Limited**

Endeavor House, Seventh Avenue,  
Team Valley Trading Estate,  
Gateshead,  
Tyne & Wear,  
NE11 0EF  
Phone: (0191) 482 0800 Fax: (0191) 491 3655  
E-mail: [technical.uk@oso-hotwater.co.uk](mailto:technical.uk@oso-hotwater.co.uk)  
E-mail: [sales.uk@oso-hotwater.co.uk](mailto:sales.uk@oso-hotwater.co.uk)

### **OSO Hotwater AS**

Industriveien 1  
3300 Hokksund - Norway  
Tel: + 47 32 25 00 00  
[oso@oso.no](mailto:oso@oso.no)  
[www.osohotwater.com](http://www.osohotwater.com)