

Maxi Accu - MA

600-1000-2000-3000-5000-10000 l.

EN



SAFETY INFORMATION
O&M INFORMATION
INSTALLATION MANUAL



OSO

HOT WATER

CONTENTS

1. Safety instructions	3
1.1 General information	3
1.2 Safety instructions for users	4
1.3 Safety instructions for installers.....	4
2. Product description	5
2.1. Product identification	5
2.2. Intended use.....	5
2.3 CE marking	5
2.4 Technical data	5
3. Installation instructions	6
3.1. Products covered by these instructions	6
3.2. Included in delivery.....	6
3.3. Product dimensions.....	6
3.4. Requirements for installation location .	7
3.5. Pipe installation.....	8
4. Initial commissioning	10
4.1. Filling with water.....	10
4.2. Control points	10
4.4. Emptying of water	10
4.5. Handover to end-user.....	10
5. User guide	10
5.1. Settings.....	10
6. Troubleshooting	10
6.1. Faults and fixes.....	10
7. Warranty conditions	11
7.1. Warranty and registration	11
7.2. Customer service.....	11
8. Removing the product	11
8.1. Removal	11
8.2. Returns scheme	11

1. SAFETY INSTRUCTIONS

1.1 General information



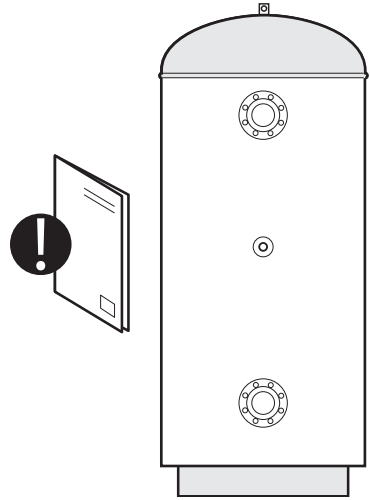

- Read the following safety instructions carefully before installing, maintaining or adjusting the buffer tank.
- Personal injury or material damage may result if the product is not installed or used in the intended manner.
- Keep this manual and other relevant documents where they are accessible for future reference.
- The manufacturer assumes compliance (by the end-user) with the safety, operating and maintenance instructions supplied and (by the installer) with the fitting manual and relevant standards and regulations in effect at the date of installation.





Symbols used in this manual:





	WARNING	Could cause serious injury or death
	CAUTION	Could cause minor or moderate injury or damage to property
	DO NOT	
	DO	





1.2 Safety instructions for users

 WARNING	
	The safety valve overflow shall NOT be sealed or plugged.
	The product shall NOT be modified or changed from its original state.
	Children shall NOT play with the product or go near it without supervision.
	Maintenance/settings shall only be carried out by persons over 18 years of age, with sufficient understanding

 CAUTION	
	The product shall not be exposed to frost, over-pressure, over-voltage or chlorine treatment. See warranty provisions.
	Maintenance/settings shall not be carried out by persons of diminished physical or mental capacity, unless they have been instructed in the correct use by someone responsible for their safety.

1.3 Safety instructions for installers

 WARNING	
	The safety valve overflow shall NOT be sealed or plugged.
	Any overflow pipe from the safety valve MUST be ≥ 18 mm inside, clear, undamaged and frost-free with a fall to the drain.
	The relevant regulations and standards, and this installation manual, must be followed.

 CAUTION	
	The product shall be placed in a room with a floor drain. The manufacturer assumes no responsibility whatsoever if this provision is not followed.
	The product shall be properly aligned vertically and horizontally, on a floor or wall suitable for the total weight of the product when in operation. See type plate.
	The product must have a clearance for servicing of 40 cm in front of front / 10 cm over the highest point.

2. PRODUCT DESCRIPTION

2.1 Product identification

Identification details for your product can be found on the type plate fixed to the product. The type plate contains details of the product in accordance with EN 12897:2016 and EN 60335-2-21, as well as other useful data. See Declaration of Conformity at www.osohotwater.com for more information.

OSO products are designed and manufactured in accordance with:

- Pressurised Equipment Directive PED2014/68/EU
- Safety standard EN 60335-2-21
- Welding standard EN ISO 3834-2

OSO Hotwater AS is certified for

- Quality ISO 9001
- Environment ISO 14001
- Work environment ISO 45001

2.2 Intended use

The Maxi Accu is designed for use as a buffer tank for heat-pumps/solar collectors (MA Heat), or as a cooler tank in cooling systems etc. (MA Cool).

2.3 UKCA marking



The UKCA mark shows that the product complies with the relevant Directives. See Declaration of Conformity at www.osohotwater.co.uk for more information.

The safety valve(s) used must be CE marked and conform to PED 2014/68/EU.

2.4 Technical data

NRF no.	Product code:	Capacity, persons	Weight, kg.	Diameter x height (mm)	Freight vol. m ³	Heating time, hours Δt 65°C	Actual vol. l.
800 1373	MA 600 Heat	-	152	ø 780x2030	1,28	-	583
800 1354	MA 1000 Heat	-	238	ø1000x2100	2,29	-	885
800 1356	MA 2000 Heat	-	362	ø1300x2440	4,25	-	-
800 1357	MA 3000 Heat	-	566	ø1500x2695	6,25	-	-
800 1358	MA 5000 Heat	-	930	ø1700x3180	9,45	-	-
800 1363	MA 10000 Heat	-	1770	ø2000x4400	17,95	-	-
800 1273	MA 600 Cool	-	152	ø 695x2030	1,28	-	583
800 1254	MA 1000 Cool	-	238	ø 840x2100	2,29	-	885
800 1256	MA 2000 Cool	-	362	ø1140x2440	4,25	-	-
800 1257	MA 3000 Cool	-	566	ø1340x2695	6,25	-	-
800 1258	MA 5000 Cool	-	930	ø1540x3180	9,45	-	-
800 1263	MA 10000 Cool	-	1770	ø1840x4400	17,95	-	-

Directive: 2010/30/EU Regulation: EU 812/2013

Directive: 2009/125/EC Regulation: EU 814/2013

Heat loss tested acc. to standard: EN 12897: 2015

3. INSTALLATION INSTRUCTIONS

3.1 Products covered by these instructions

Maxi Accu Heat:		Maxi Accu Cool:	
800 1373	MA 600	800 1273	MA 600
800 1354	MA 1000	800 1254	MA 1000
800 1356	MA 2000	800 1256	MA 2000
800 1357	MA 3000	800 1257	MA 3000
800 1358	MA 5000	800 1258	MA 5000
800 1363	MA 10000	800 1263	MA 10000

3.2 Included in delivery

Ref no.	Number of	Description
1	1	Buffer tank without electric backup
2	1	Installation manual (this document)
3	1	Safety valve 3 bar

3.3 Product dimensions

All dimensions in mm.

Product.	A	B	C	D	Ø HEAT	Ø COOL
MA 600	2030	1495	375		780	695
MA 1000	2100	1650	440		1000	840
MA 2000	2440	1650	405		1300	1140
MA 3000	2695	1710	465		1500	1340
MA 5000	3180	2490	625		1700	1540
MA 10000	4400	3635	705		2000	1840

Tolerance +/- 10 mm.

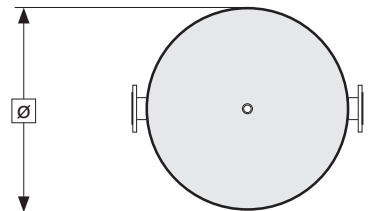
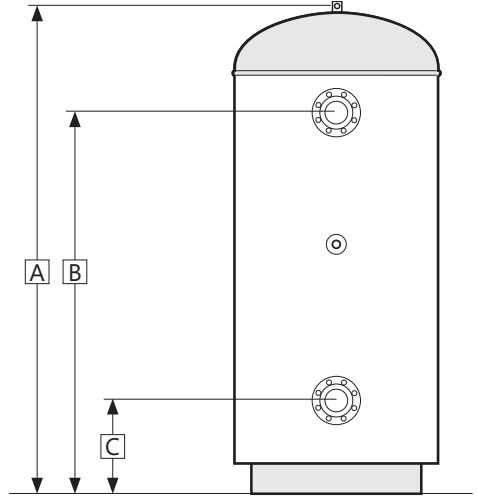
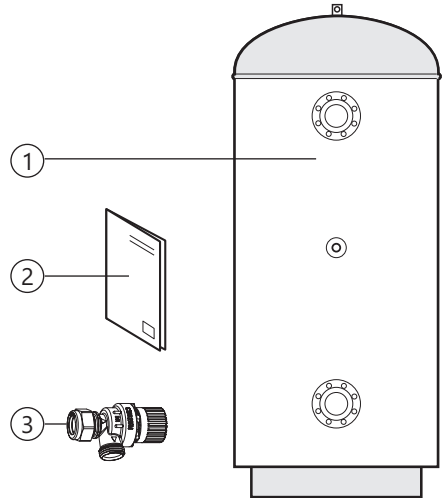

3.3.1 Delivery

The product should be transported carefully as shown, with packaging.

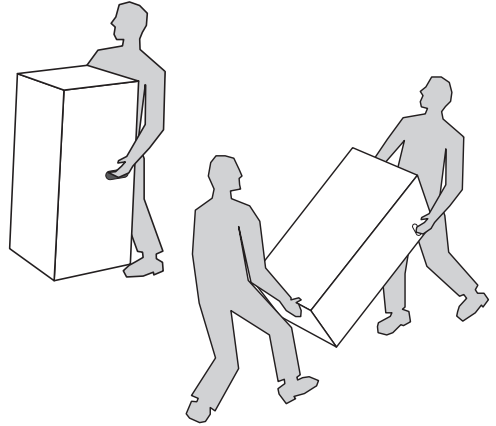

⚠ CAUTION
Pipe stubs, valves etc. should not be used to lift the product as this could cause malfunctions.

3.4 Requirements for installation location and positioning

⚠ CAUTION	
❗	The product shall be placed in a room with a floor drain. The manufacturer assumes no responsibility whatsoever if this provision is not followed.
❗	The product shall be placed in a dry and permanently frost-free position.
❗	The product shall be placed on a floor or wall suitable for the total weight of the product when in operation. See type plate.
❗	The product must have a clearance for servicing of 40 cm in front of front / 10 cm over the highest point.
❗	The product shall be easily accessible for servicing and maintenance.

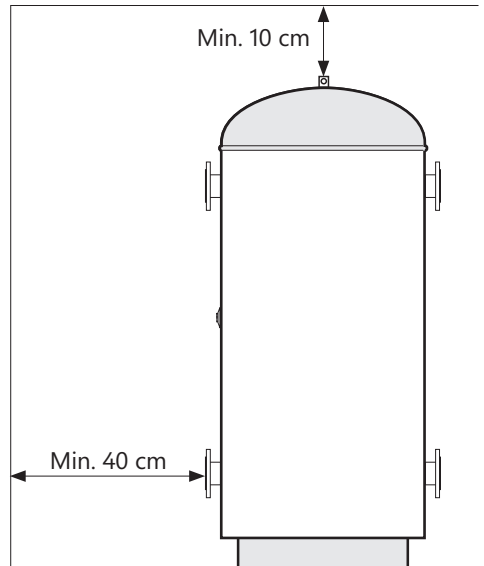
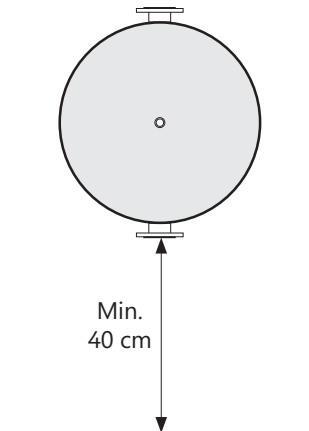

3.5 Pipe installation

Approved pipes of the correct size should be used for installation. The relevant standards and regulations must be followed.

No.	Dimension	Connection description
1	3/4" internal thread	Venting
2	DN 80 PN 6	2 x Return (600 l.)
2	DN 100 PN 6	2 x Return (1000 l.)
2	To order	Return (2000-10 000 l.)
3	1/2" internal thread	Safety valve / thermometer
4	DN 80 PN 6	2 x Return (600 l.)
4	DN 100 PN 6	2 x Return (1000 l.)
4	To order	Return (2000-10 000 l.)

3.5.1 Incoming water pressure

The product is designed for a max. operating pressure of 6 bar.

3.5.2 Fitting pipes

A) Run a pipe of suitable size to the connections shown, and affix with suitable sealant. Unused connections must be plugged securely.

3.5.3 Safety valve

The supplied SV-381 safety valve is dimensioned for 10kW effect. It shall be fitted in connection (3) by removing the nut and olive from the valve, then inserting the exposed 1/2" thread into connection (3).

Ensure that your installation has sufficient dimensioning of safety equipment in accordance with PED 2014/68 / EU.

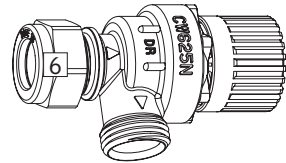
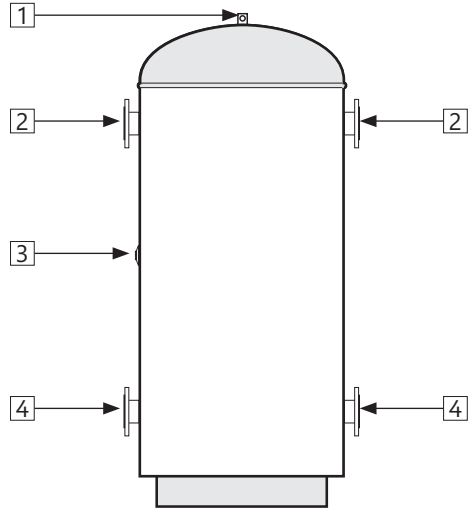

3.5.4 Fitting instructions

⚠ CAUTION	
❗	The product shall be placed in a room with a floor drain. The manufacturer assumes no responsibility whatsoever if this provision is not followed.
❗	The product shall be properly aligned vertically and horizontally, on a floor suitable for the total weight of the product when in operation. See type plate.
❗	The product must have a clearance for servicing of 40 cm in front of front / 10 cm over the highest point.

3.5.5 Fitting recommendation

RECOMMENDATION	
-	For installation in a rooms which does not conform to the wetroom standard, a watertight drip tray with overflow pipe \geq 18 mm. inside diameter should be fitted under the product, in addition to an automatic stop cock with sensor. This will prevent possible material damage.

4. INITIAL COMMISSIONING

4.1 Filling with water

First check that all pipes are connected correctly. Then proceed as follows:

- A) Open for venting at a point in the system higher than the top of the tank; use e.g. the 3/4" top connection on the product.
- B) Open the water supply to the product. When water flows out of the venting point, the tank is full and the vent can be sealed.

4.2 Control points

- A) Check that all pipe connections to/from the product are tight and not leaking.
- B) Check that the product is standing firmly vertically and horizontally.

4.3 Emptying of water

⚠ WARNING

The water temperature in the product may exceed 75°C and could cause scalding. Use caution when emptying the product.

- A) Shut off/disconnect the heat source.
- B) Close the incoming water supply.
- C) Open a high positioned connection for venting – leave open (prevents vacuum).
- D) The product is emptied by disconnecting the lower return pipe (1).
After emptying, the lower return pipe shall be reconnected and the vent closed before the product is refilled.

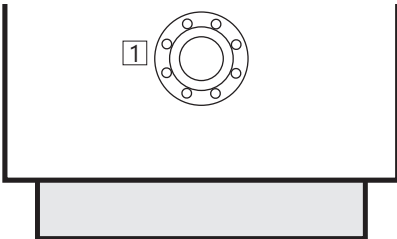

4.4 Handover to end-user

THE INSTALLER MUST:

- Brief the end-user on safety and maintenance instructions.
- Brief the end-user on settings and emptying the product.
- Hand this installation manual over to the end-user.
- Enter contact details on the type plate on the product.

5. USER GUIDE

5.1 Settings

The product does not require any special settings.

5.2 Maintenance

MAINTENANCE INSTRUCTIONS	
❗	Maintenance should be carried out by persons over 18 years of age, with sufficient understanding.
❗	Annual inspection of safety valve:
-	Open valve for 1 min. by turning knob (1) approx. 90 degrees counterclockwise to the open position.
-	Visually check that the water is flowing freely to the drain.
-	YES = OK. Close the valve by turning knob (1) further counterclockwise.
-	NO = NOT OK. Disconnect power supply / shut off water supply. Contact installer.

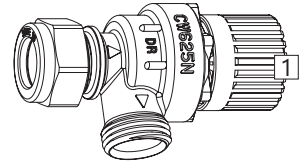

6. TROUBLESHOOTING

6.1 Faults and fixes

If problems arise when the product is in use, check for these possible faults:

1. Water leaking from pipe connection. Possible cause: Pipe connection is loose or sealant is insufficient. Possible solution: Tighten pipe connection, replace sealant if necessary.
2. Water leaking from the tank, not the pipe connection. Possible cause: Leakage from the steel tank. Possible solution: Check if it is possible to see the leak point. Contact installer.

If you are unsure what is wrong, contact the installer (see product type plate) or OSO Hot-water AS - see section 6.1.

6. WARRANTY CONDITIONS - applies to UK only

1. Scope

OSO Hotwater AS (hereinafter called OSO) warrants for 2 years from the date of purchase, that the Product will: i) conform to OSO specification, ii) be free from defects in materials and workmanship, subject to conditions below. All components carry a 2-year warranty.

The warranty is voluntarily extended by OSO to 5 years for the stainless steel inner tank. The conditions and limitations set out below shall apply.

2. Coverage

If a defect arises and a valid claim is received within the statutory warranty period, at its option and to the extent permitted by law, OSO shall either; i) repair the defect, or; ii) replace the product with a product that is identical or similar in function, or; iii) refund the purchase price.

If a defect arises and a valid claim is received after the statutory warranty period has expired, but within the extended warranty period, OSO will supply a product that is identical or similar in function. OSO will in such cases not cover any other associated costs.

Any exchanged Product or component will become the legal property of OSO. Any valid claim or service does not extend the original warranty. The replacement Product or part does not carry a new warranty.

3. Conditions

The Product is manufactured to suit most public water supplies. However, there are certain water chemistries (outlined below) that can have a detrimental effect on the Product and its life expectancy. If there are uncertainties regarding water quality, the local water supply authority can supply the necessary data.

The warranty applies only if the conditions set out below are met in full:

- The Product has been installed by a professional installer, in accordance with the instructions in the installation manual and all relevant Codes of Practice and Regulations in force at the time of installation.
- The Product has not been modified in any way, tampered with or subjected to misuse and no factory fitted parts have been removed for unauthorized repair or replacement.
- The Product has only been connected to a domestic mains water supply in compliance with the European Drinking Water Directive EN 98/83 EC, or latest version. The water should not be aggressive, i.e. the water chemistry shall comply with the following:

- Chloride	< 250 mg / L
- Electric Conductivity (EC) @25°C	< 750 uS / cm
- Saturation Index (LSI) @80°C	> - 1,0 / < 0,8
- pH level	> 6,0 / < 9,5

- The immersion heater has not been exposed to hardness levels exceeding 5°dH (90 ppm CaCO₃). A water softener is recommended in such cases.
- Any disinfection has been carried out without affecting the Product in any way whatsoever. The Product shall be isolated from any system chlorination.
- The Product has been in regular use from the date of installation. If the Product is not intended to be used for 60 days or more, it must be drained.
- Service and/or repair shall be done according to the installation manual and all relevant codes of practice. Any replacement parts used shall be original OSO spare parts.
- Any third-party costs associated with any claim has been authorized in advance by OSO in writing.
- The purchase invoice and/or installation invoice, a water sample as well as the defective product is made available to OSO upon request.

Failure to follow these instructions and conditions may result in product failure, and water escaping from the Product.

4. Limitations

The warranty does not cover:

- Any fault or costs arising from incorrect installation, incorrect application, lack of regular maintenance in accordance with the installation manual, neglect, accidental or malicious damage, misuse, any alteration, tampering or repair carried out by a non-professional, any fault arising from the tampering with or removal of any factory fitted safety components or measures.
- Any consequential damage or any indirect loss caused by any failure or malfunction of the Product whatsoever.
- Any pipework or any equipment connected to the Product.
- The effects of frost, lightning, voltage variation, lack of water, dry boiling, excess pressure or chlorination procedures.
- The effects of stagnant (de-aerated) water if the Product has been left unused for more than 60 days consecutively.
- Damage caused during transportation. Buyer shall give the carrier notice of such damage.
- Costs arising if the Product is not immediately accessible for servicing.

The warranty is void if the Service Log Book in this manual has not been completed by installer and the service interval record has not been filled in after each service/inspection.

These warranties do not affect the Buyer's statutory rights.

The warranty conditions are not valid outside of the UK.

6.1 Customer service

In case of problems that cannot be resolved with the aid of the troubleshooting guide in this installation manual, contact either:

A) The installer who supplied the product.

B) OSO Hotwater (UK) Limited:

Phone: (0191) 482 0800

Fax: (0191) 491 3655

E-mail: technical.uk@oso-hotwater.co.uk

7. REMOVING THE PRODUCT

7.1 Removal

- A) Disconnect the power supply.
- B) Shut off incoming cold water supply.
- C) Empty the product of water – see section 4.4.
- D) Disconnect all pipes.
- E) The product can now be removed.

7.2 Returns scheme

This product is recyclable and should be taken to the environmental recycling centre. If the product is to be replaced with a new one, the installer can take the old cylinder away for recycling.

OSO

HOTWATER

OSO Hotwater (UK) Limited

Endeavor House, Seventh Avenue,
Team Valley Trading Estate,
Gateshead,
Tyne & Wear,
NE11 0EF

Phone: (0191) 482 0800 Fax: (0191) 491 3655

E-mail: technical.uk@oso-hotwater.co.uk

E-mail: sales.uk@oso-hotwater.co.uk

Manufactured by

OSO Hotwater AS

Industriveien 1
3300 Hokksund - Norway
Tel.: +47 32 25 00 00

oso@oso.no

www.osohotwater.com